

**30SMD Auto Head Lights 3030 Brake And Turn Signal Lights 10W**

Our Product Introduction

for more products please visit us on [automotive-ledlight.com](http://automotive-ledlight.com)

**Basic Information**

- Place of Origin: China
- Brand Name: HOUYI
- Model Number: 1156 3030 30
- Minimum Order Quantity: 6 pieces
- Price: \$2.85/pieces 6-499 pieces
- Packaging Details: in bulk

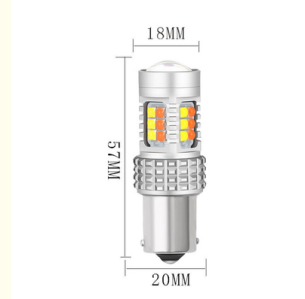

**Product Specification**

- Model: 500, PUNTO EVO (199\_), 500 C, 500C / 595C / 695C (312\_), RITMO (138A\_), GRANDE PUNTO (199\_), Strada, 124 Spider (348\_), PUNTO (199\_), PUNTO, 500 (312\_), Titan 410S, SF213, Titan 350S, Puma 168 / A, Puma 178, Mickey 123, Alexander 126H, Jumbo 140, Puma 177
- Year: 2009-2016, 2011-2016, 2008-2016, 2010-2016, 2008-2016, 2009-2016, 1981-1987, 1983-1987, 2012-, 2016-, 1976-1991, 1975-1991, 2009-, 1976-1991, 2008-, 2007-2012, 1981-1987, 1976-1991, 2008-2012, 1976-1991, 1976-1991, 1971-1991, 1976-1991, 1972-1991, 1972-1991
- OE No.: 123
- Car Fitment: ABG, Abarth
- Warranty: 1 Year
- Car Model: Universal
- Voltage: 12V



**More Images**

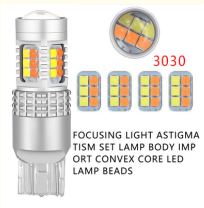
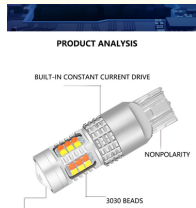

**Product Description**

factory 30SMD auto head lights 3030 others car light accessories reversing headlamp brake turn signal light  
Product Description

Our Product Introduction



## 1156/1157/7443 DRL

DRL + TURN SIGNAL BIFUNCTIONAL



## INTEGRATED CONSTANT CURRENT DECODING DRIVER

PREVENTING THE PROTECTION FUNCTION OF HIGH-VOLTAGE OVER-CURRENT CIRCUIT TO ENSURE THE STABLE OPERATION OF THE VEHICLE



智能芯片



稳压驱动

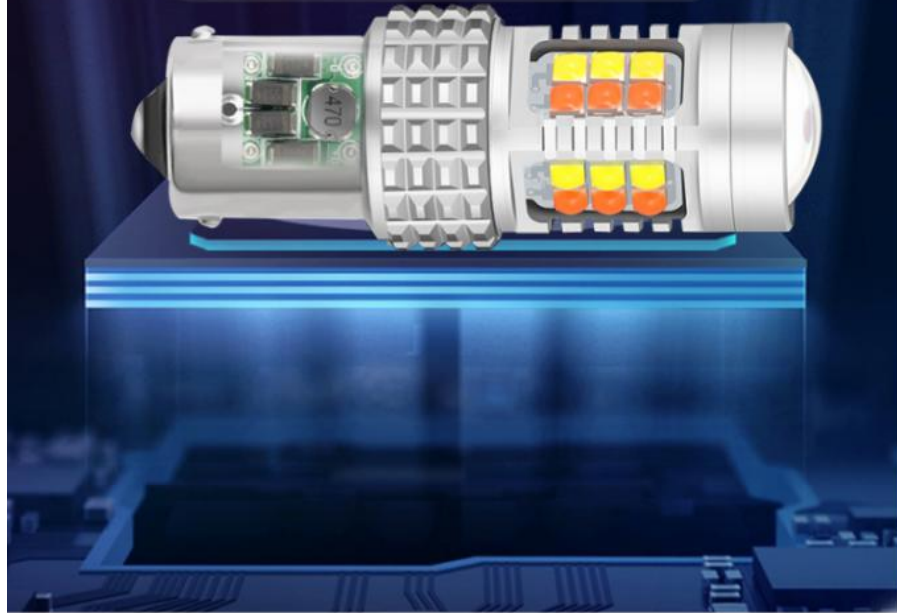

## PRODUCT ANALYSIS

BUILT-IN CONSTANT CURRENT DRIVE

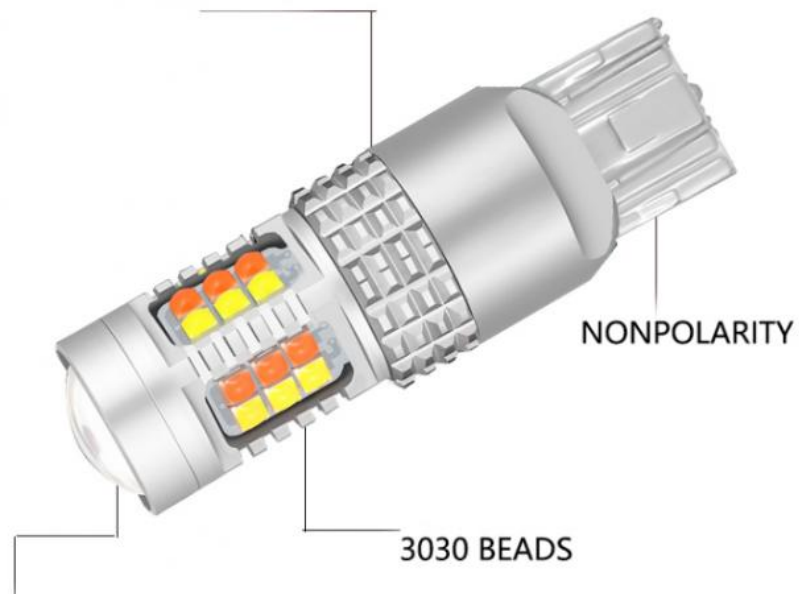

INNER HIGH TEMPERATURE CONVEX LENS

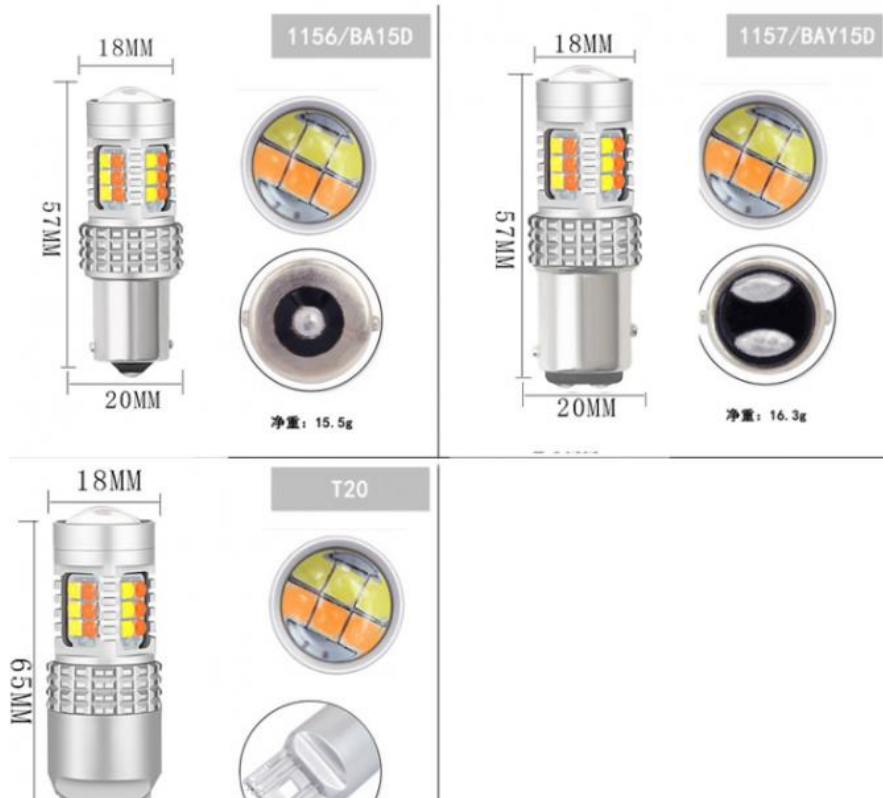

HIGH-DEFINITION CONVEX LENS  
, FAR MORE LIGHT-GATHERING  
| WIDE RANGE OF MORE CLEAR  
BEADS



MATERIAL DESIGN GOOD HEAT DISSIPATION PERFORMANCE, USING ALUMINUM ALLOY MATERIALS

HIGH QUALITY INTEGRATED CIRCUITS  
360-DEGREE HEAT DISSIPATION

HIGH-GRADE COOLING ALUMINUM  
WITH LOW POWER CONSUMPTION

**GOOD HEAT DISSIPATION**  
**SUPER BRIGHT ADVANTAGE**



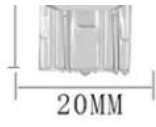

净重: 16.3g



item	value
OE No.	123
Place of Origin	China

Warranty	1 year
Model Number	1156-3030-30
Car Model	Universal
Brand Name	HOUYI
Voltage	12V
Power	10W
LED Chip	High Power
LED Quantity	30SMD
Keyword	led headlight

## Packing & Delivery



## FAQ

### 1. how can we guarantee quality?

- Raw material checking before production
- Full checking after every individual process finished
- Full checking after production half-done
- Light and Appearance checking before packed and shipping

### 2.what can you buy from us?

Our company is specialized in producing a series of LED products of large and small power, such as all kinds of daily lights, indoor lights, hooligan lights, overhead lights, broad lights, brake lights, turn signals, car LED headlamps, T10 headlights, automobile LED daytime light strip, and so on.

### 3. how do you make our business long-term and good relationship?

- We keep good quality and competitive price to ensure our customers benefit ;
- We respect every customer as our friend and we sincerely do business and make friends with them, no matter where they come

### 4. what services can we provide?

Accepted Delivery Terms: EXW, FOB, CFR, CIF, DDU ;

Accepted Payment Currency:USD,EUR,GBP,CNY;

Accepted Payment Type: D/P D/A,Credit Card,Cash;

Language Spoken:English

### 5.Can I have customized package and logo on the products ?

yes , OEM packaging and ODM service on request.

**HAOHI** HAOHI CO., LTD

☎ 15813693852    ✉ hedva511@163.com    🌐 automotive-ledlight.com

Room 803, Chevalier House, 45-51 Chatham Road South, Tsim Sha Tsui, Kowloon, Hong Kong.